

# PowerMouse

The FlarmMouse successor

Version 1.16



LXNAV d.o.o. • Kidričeva 24, 3000 Celje, Slovenia • tel +386 592 33 400 fax +386 599 33 522  
[info@lxnav.com](mailto:info@lxnav.com) • [www.lxnav.com](http://www.lxnav.com)

<b>1</b>	<b>Important Notices</b>	<b>3</b>
1.1	Limited Warranty	3
1.2	Declaration of Conformity	4
1.2.1	FCC	4
1.2.2	CE	5
<b>2</b>	<b>Packing Lists</b>	<b>6</b>
<b>3</b>	<b>Basics</b>	<b>7</b>
3.1	LXNAV PowerMouse at a Glance	7
3.1.1	LXNAV PowerMouse Features	7
3.1.2	Interfaces	8
3.1.3	Flarm antenna colour coding	8
3.1.4	Options	8
3.1.5	Technical Data	8
3.2	ADS-B module	8
<b>4</b>	<b>System Description</b>	<b>9</b>
4.1	Switching on the Unit	9
4.2	Normal operation	9
4.3	Bluetooth	9
<b>5</b>	<b>Installation</b>	<b>10</b>
5.1	Connecting LXNAV PowerMouse	10
5.2	Connecting Antennas	10
5.3	USB port	11
5.4	Wiring	11
5.4.1.1	PowerMouse PORT1 and PORT2 pinout (RJ45)	11
5.4.1.2	PowerMouse RF connector side description	12
5.4.1.3	PowerMouse – FlarmView	12
5.4.1.4	PowerMouse – FlarmLED	13
5.4.1.5	PowerMouse – FlarmLED – Oudie	13
5.4.1.6	PowerMouse – FlarmView – Sxxx Vario	14
5.4.1.7	PowerMouse – LX9xxx – FlarmView	14
<b>6</b>	<b>Data transfer</b>	<b>15</b>
6.1	Firmware Update	15
6.1.1	Firmware update via USB port (USB stick)	15
6.1.2	ADS-B firmware update via Flash Loader	15
6.1.3	ADS-B firmware update via LXxxxx	15
6.2	Configuring PowerMouse	16
6.2.1	Configuring PowerMouse settings with PowerFLARM config	16
6.2.2	PowerMouse configuration by using Flarm configuration tool	16
6.3	Saving flight on the USB stick	20
6.4	Updating the obstacle database	20
<b>7</b>	<b>Revision History</b>	<b>22</b>

# 1 Important Notices

The LXNAV PowerMouse system is designed for VFR use only as an aid to prudent navigation. All information is presented for reference only.

Information in this document is subject to change without notice. LXNAV reserves the right to change or improve their products and to make changes in the content of this material without obligation to notify any person or organisation of such changes or improvements.



A Yellow triangle is shown for parts of the manual which should be read carefully and are important for operating the LXNAV PowerMouse system.



Notes with a red triangle describe procedures that are critical and may result in loss of data or any other critical situation.



A bulb icon is shown when a useful hint is provided to the reader.

## 1.1 Limited Warranty

This LXNAV PowerMouse product is warranted to be free from defects in materials or workmanship for two years from the date of purchase. Within this period, LXNAV will, at its sole option, repair or replace any components that fail in normal use. Such repairs or replacement will be made at no charge to the customer for parts and labour, the customer shall be responsible for any transportation cost. This warranty does not cover failures due to abuse, misuse, accident, or unauthorised alterations or repairs.

THE WARRANTIES AND REMEDIES CONTAINED HEREIN ARE EXCLUSIVE AND IN LIEU OF ALL OTHER WARRANTIES EXPRESSED OR IMPLIED OR STATUTORY, INCLUDING ANY LIABILITY ARISING UNDER ANY WARRANTY OF MERCHANTABILITY OR FITNESS FOR A PARTICULAR PURPOSE, STATUTORY OR OTHERWISE. THIS WARRANTY GIVES YOU SPECIFIC LEGAL RIGHTS, WHICH MAY VARY FROM STATE TO STATE.

IN NO EVENT SHALL LXNAV BE LIABLE FOR ANY INCIDENTAL, SPECIAL, INDIRECT OR CONSEQUENTIAL DAMAGES, WHETHER RESULTING FROM THE USE, MISUSE, OR INABILITY TO USE THIS PRODUCT OR FROM DEFECTS IN THE PRODUCT. Some states do not allow the exclusion of incidental or consequential damages, so the above limitations may not apply to you. LXNAV retains the exclusive right to repair or replace the unit or software, or to offer a full refund of the purchase price, at its sole discretion. SUCH REMEDY SHALL BE YOUR SOLE AND EXCLUSIVE REMEDY FOR ANY BREACH OF WARRANTY.

To obtain warranty service, contact your local LXNAV dealer or contact LXNAV directly.

## 1.2 Declaration of Conformity



### 1.2.1 FCC

Product: Flarm receiver with GPS  
Type reference: PowerMouse  
Manufacturer: LXNAV d.o.o., Kidričeva 24, 3000 Celje,  
Slovenia  
Trademark: LXNAV  
FCC ID: 2ASPHLXNAVAM  
Operating frequencies: 902.4MHz-927.8MHz  
Ratings: 8-36VDC  
Protection calss: III  
Testing Method: 47 CFR Part 15, Subpart B (Clause 15.107 and  
15.109)

This device complies with Part 15 of the FCC.

Operation is subject to the following two conditions:

- (1) this device may not cause harmful interference, and
- (2) this device must accept any interference received, including interference that may cause undesired operation.

The following test reports are subject to this declaration:

Test report number: T251-0588/19 Issue date:8.8.2019

Within the USA, the device may only be used in transportation vehicles such as aircraft or motor vehicles.

The following importer is responsible for this declaration:

Company name: Craggy Aero  
Company address: 3901 River CT, Hornbrook, CA 96044  
Telephone: 530-905-0062

## 1.2.2 CE

---

### *Identification of product*

PowerMouse

---

### *Manufacturer*

LXNAV d.o.o.  
Kidričeva 24, 3000 Celje, Slovenija

---

### *Related standards*

EMC directive 2004/108/EC

---

*This product is designed to comply with standards/regulations and technical specifications stated above. This certificate is granted subject to the LXNAV quality rules on product certification.*

---

---

### *Remark*

The product is designed to comply with s LXNAV standards and standards harmonised with directive 2004/108/EC: EN 55022:1998+A1:2000+A2:2003, class A; EN 55024:1998+A1:2001+A2:2003; En 61000-3-2:2000+A2:2005; EN 61000-3-3:1995+A1:2001+A2:2005

## 2 Packing Lists

- PowerMouse
- Dipole FlarmAntenna
- Bluetooth Antenna
- GPS antenna
- 2<sup>nd</sup> Dipole FlarmAntenna is optional
- USB stick
- Flarm power supply cable
- FlarmView/FlarmLED (Optional)

## 3 Basics

### 3.1 LXNAV PowerMouse at a Glance

PowerMouse is standalone PowerFlarm<sup>®</sup> with external GPS antenna, USB socket and internal Bluetooth module.

It's a collision avoidance device, designed for gliders as well as for other participants in the air. FLARM<sup>®</sup> is in widespread use and features include:

- Display of nearby Flarm traffic with warning visually and acoustically of approaching other aircraft or fixed obstacles (where database has been installed)
- intelligent motion prediction which minimizes nuisance alarms and supports situational awareness
- integration with over 50 compatible products by other manufacturers (e.g. PDA moving maps) through open serial port protocol
- USB socket for easy uploads and downloads, IGC-format flight recording and OLC-approval
- based on award-winning original FLARM<sup>®</sup> design, endorsed by FAI, IGC/OSTIV and EASA (AMC Part 21, Part M)
- optional diamond-level IGC-approval with/without engine noise sensor (ENL)
- a typical radio range that can be verified with online radio range analyser
- powerful 72-channel high-precision uBlox NEO8-GPS module
- full compatibility with wide range of Flarm-licensed products
- operation on a license-free radio band, not based on transponder technology
- small size and simple installation

PowerMouse is available in 5 variants:

- PowerMouse with Flight recorder (Not approved by IGC), with enabled SAR (search and rescue) function
- PowerMouse with IGC approved Flight recorder (Up to Diamonds) and SAR function
- PowerMouse with IGC approved Flight recorder (Up to Diamonds), Engine noise sensor and SAR function
- RFB – second Flarm antenna (dual antenna diversity) -available for all versions (Non IGC, IGC and IGC ENL)
- ADS-B module as an option

#### 3.1.1 LXNAV PowerMouse Features

- USB stick socket for configuration of Flarm, firmware update or storing IGC flights
- IGC flight recorder (Up to Diamond level)
- Optionally preloaded obstacles (where databases are available) – Obstacles are not any freer of charge.
- Expandable to all standard Flarm displays
- Designed for FlarmView
- Low current consumption
- Second Flarm antenna

### 3.1.2 Interfaces

- Two Standard Flarm/IGC port on RJ45 with serial RS232 interface
- USB Port (up to 2.0)
- Bluetooth (Not available in US version)
- 2xSMA for flarm antenna (US version has reverse polarity SMA)
- 1xSMA for ADSB antenna



Default baud rate of PowerMouse is set to 19200bps. In case, that you have any problems with Flarm indicator (FlarmView), please check baud rate setting on it.

### 3.1.3 Flarm antenna colour coding

Red marked antenna is for Europe (868.2Mhz)

Blue marked antenna is for USA, CANADA, Australia (915MHz)

Green marked antenna is for USA with reverse polarity SMA (915MHz) – FCC approved

### 3.1.4 Options

One or more external Flarm Displays can be connected (FlarmView/FlarmLED)

### 3.1.5 Technical Data

- Power input 8-36 V DC
- Consumption 1.02W (85mA @12V) excl. power for USB stick
- Weight 160 g
- 55mm x 90mm x 25mm

## 3.2 ADS-B module

PowerMouse device has a possibility to have an internal ADSB module, which is the ADSB IN module. All four variants can have the ADSB.

ADS-B module is not a standard part of the PowerMouse, therefore when ordering you have to order PowerMouse with ADSB.

ADS-B can receive MODE S transponders with ADS-B OUT. You will see all traffic equipped with mode S transponders.



ADS-B module can be retrofitted into PowerMouse units without it (except for serial numbers from 1-100).



## **4 System Description**

### **4.1 Switching on the Unit**

Unit is switched on automatically, when it gets valid power supply from either PORT1 or PORT2 RJ45 connector.

### **4.2 Normal operation**

PowerMouse goes into normal operating mode, when it receives signals from enough GPS satellites.

Then the device becomes visible to and receives data from other FLARM devices.

### **4.3 Bluetooth**

To connect to the PowerMouse via Bluetooth, you must search on a PDA/Smartphone for Bluetooth enabled devices in range. Click PAIR or CONNECT to connect to the PowerMouse. Device will appear as LXNAV-FPM-(5-digit serial). Device doesn't require any pairing password.

Bluetooth is always ON and cannot be configured. Purpose of Bluetooth is to send Flarm objects to the other Bluetooth device. When device is on Bluetooth LED will flash blue every 3 seconds, when device is successfully connected in will flash twice every second.

## 5 Installation

PowerMouse can be installed behind the instrument panel.

### 5.1 Connecting LXNAV PowerMouse

LXNAV PowerMouse is connected to DC power supply using PF POWER 12 VDC cable. Red wire goes to + positive and blue wire goes to – ground.

External indicator can be connected via a splitter or directly to the other port.



Instrument has no internal fuse. **3A external fuse is required!**

### 5.2 Connecting Antennas

PowerMouse has 4 connectors for different antennas. Two SMA connectors (A and B) are for Flarm Antennas and there is one antenna for the ADSB (optionally). GPS connector serves for GPS antenna and BT connector for Bluetooth antenna.



Following Flarm Antennas are available:

- Short Dipole (90°)  $\lambda/4$
- Long dipole (90°)  $\lambda/2$
- Flat folded dipole
- Classic dipole
- Antenna with ground plate



For better range, Flarm antennas must be positioned vertically.

For additional information about installation you may have a look at:



<https://flarm.com/wp-content/uploads/man/FTD-041-Application-Note-FLARM-Antenna-Installation.pdf>



1x Flarm Flat dipole antenna is included in the package.

When you buy RFB option, the second Flat dipole antenna is included as well.

### 5.3 USB port

USB port serves as a SD card on other Flarm devices (FlarmMouse).

Advantage of the USB is, that you can install PowerMouse behind the panel and connect USB extension cable to the front panel.

User can use it for:

- Updating PowerMouse
- Changing PowerMouse settings (flarmcfg.txt)
- Downloading flights



USB is active only when the device is powered ON.

It supports up to USB 2.0 type

### 5.4 Wiring

#### 5.4.1.1 PowerMouse PORT1 and PORT2 pinout (RJ45)

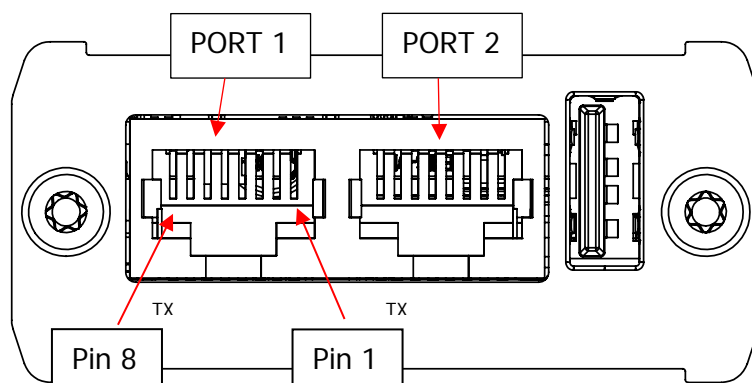

Pin number	Description
1	+ Power input
2	+ Power input
3	3.0V Indicator power output
4	Ground
5	Data output (TX)
6	Data input (RX)
7	- Power input
8	- Power input



Underneath each port there are TX (transmit) and RX (receive) status LEDs that flash green when that port is receiving or transmitting data.

**5.4.1.2 PowerMouse RF connector side description**

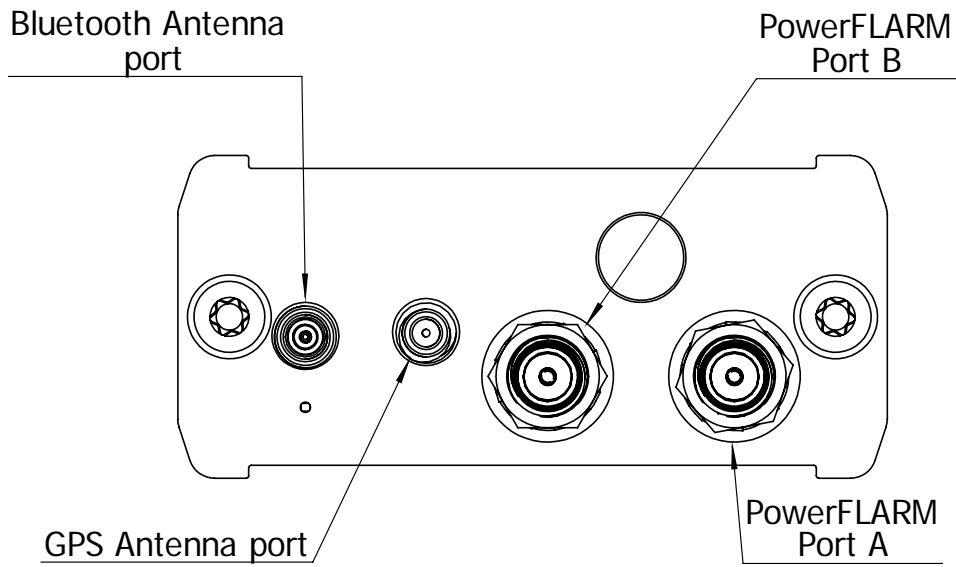

Connector description	Connector type
Bluetooth Antenna port	MCX
GPS Antenna port	SMC
PowerFLARM Port A	SMA
PowerFLARM Port B	SMA

**5.4.1.3 PowerMouse – FlarmView**

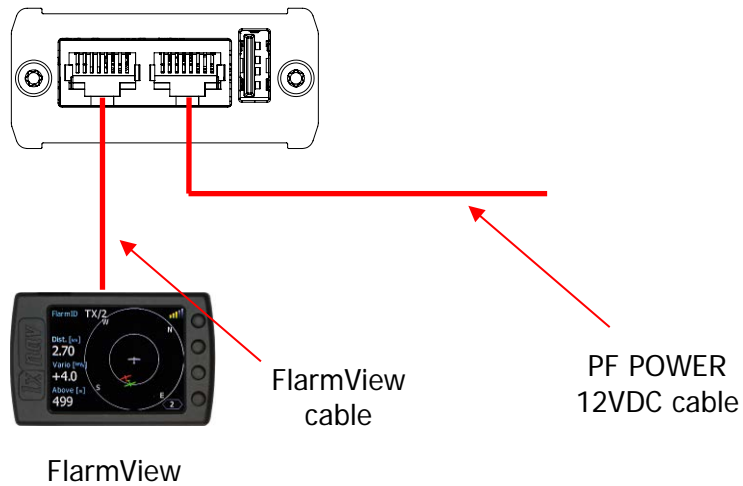

### 5.4.1.4 PowerMouse – FlarmLED

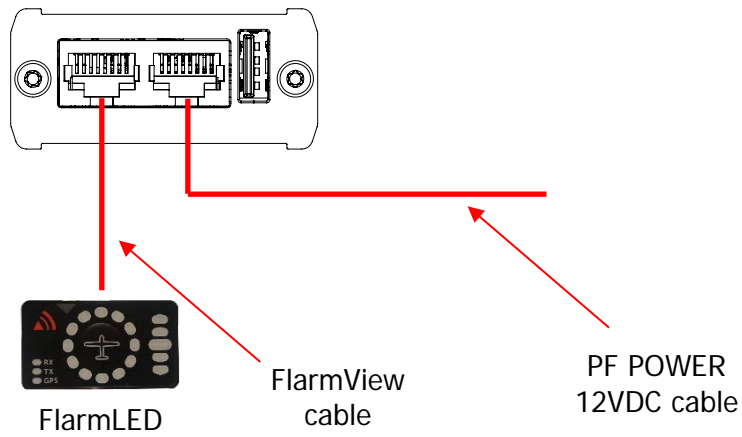

### 5.4.1.5 PowerMouse – FlarmLED – Oudie

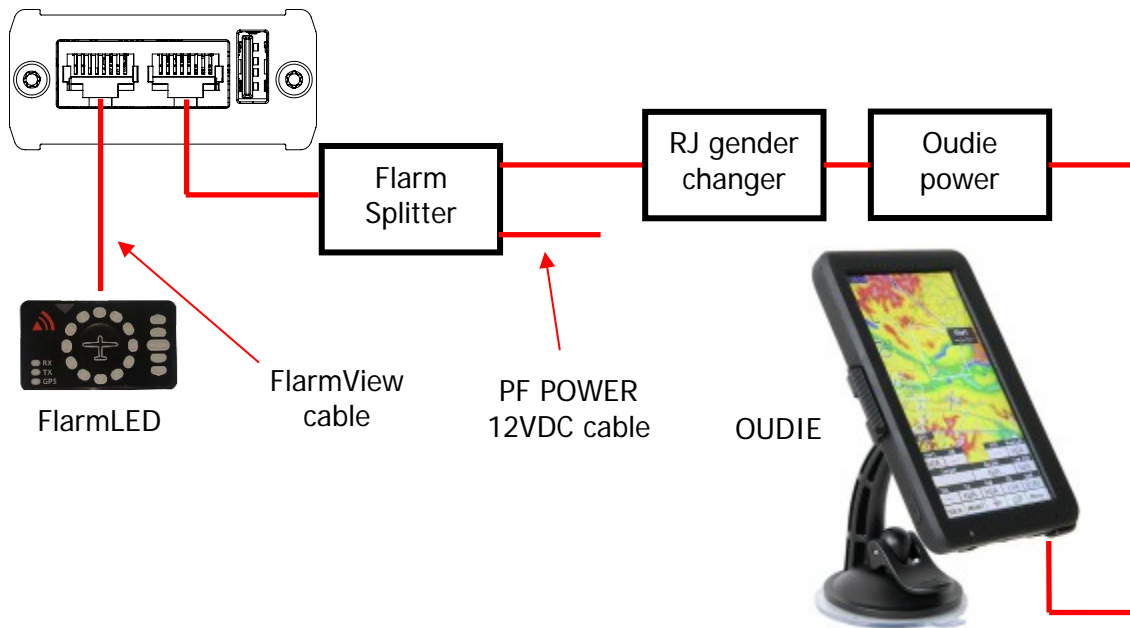

### 5.4.1.6 PowerMouse – FlarmView – Sxxx Vario

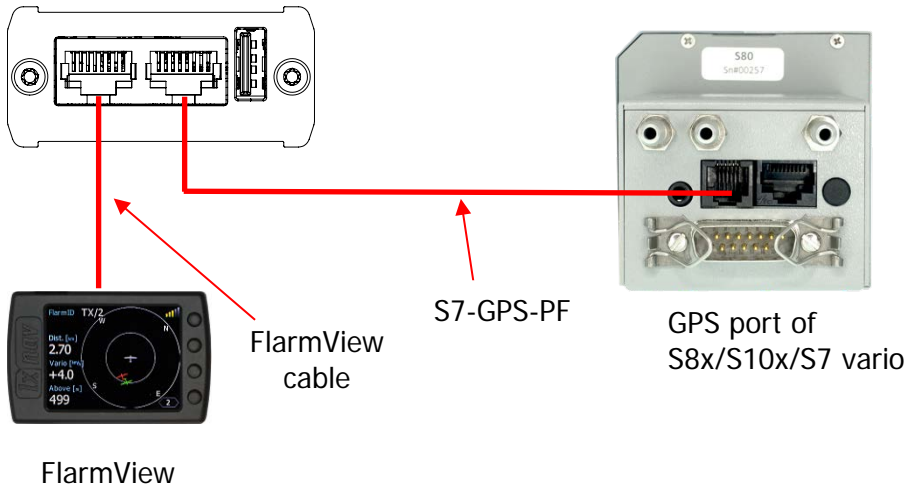

### 5.4.1.7 PowerMouse – LX9xxx – FlarmView

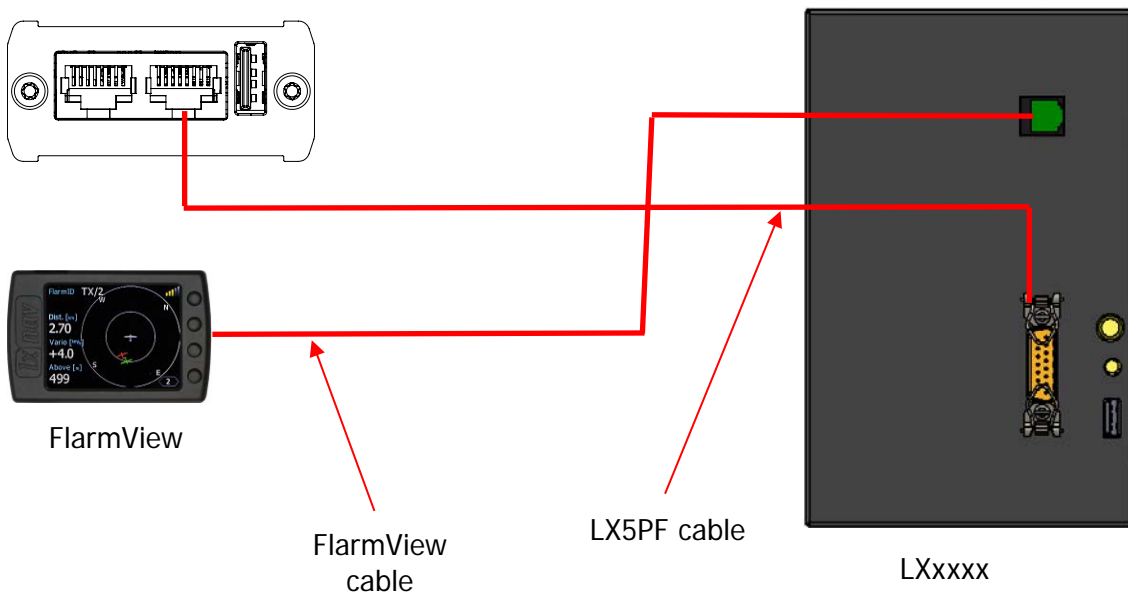

## 6 Data transfer

### 6.1 Firmware Update

#### 6.1.1 Firmware update via USB port (USB stick)

This Method is the easiest one and therefore preferred. The firmware update will be executed, when the system finds the file named `flarm_x*.fw` (x= version nr.) on the USB stick root. This file can be downloaded at [www.flarm.com](http://www.flarm.com).

##### Update procedure:

- Switch off the Flarm and insert the USB stick.
- Now switch on the device
- The procedure will start automatically, it takes about one minute.
- When ready, switch off the Flarm
- Please delete the firmware file from the USB stick after the update

#### 6.1.2 ADS-B firmware update via Flash Loader

This method is used if you wish to update an ADS-B module in PowerMouse.

You can get flash loader at: <https://gliding.lxnav.com/lxdownloads/firmware/> (S7 PC update tool).

For the update you need file named `_x*.lxfw` (x= version nr.) on your computer.

##### Update procedure:

- Switch off the Flarm and connect it to your PC via Port 2.
- Select communication port to which your PowerMouse is connected to
- Select baudrate 57600
- Select root direction of your `.lxfw` file
- Press Flash
- Turn the device back on

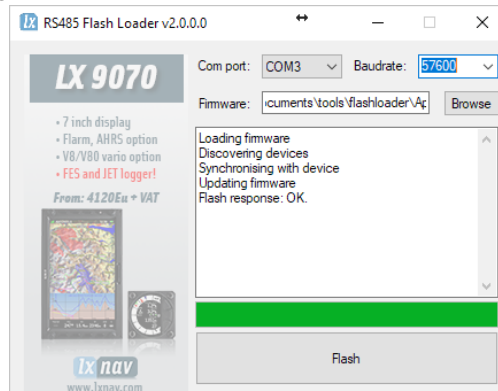

To update ADS-B module, a cable **Flarm update 12V DC** is required and a Comm port on PC.

#### 6.1.3 ADS-B firmware update via LXxxxx

If Power mouse is connected to LXxxxx via LX5PF cable, firmware update can be performed directly from LXxxxx. If LXxxxx has no built in flarm, just enter password 89891 and select file with ADSB firmware **App\_FADS\_X.XX.lxfw**.

In case you have built in flarm and connected external PowerMouse, before update procedure described above, enter password 49147.

## 6.2 Configuring PowerMouse

### 6.2.1 Configuring PowerMouse settings with PowerFLARM config

PowerFlarm config is available at:

<https://gliding.lxnav.com/lxdownloads/software/>

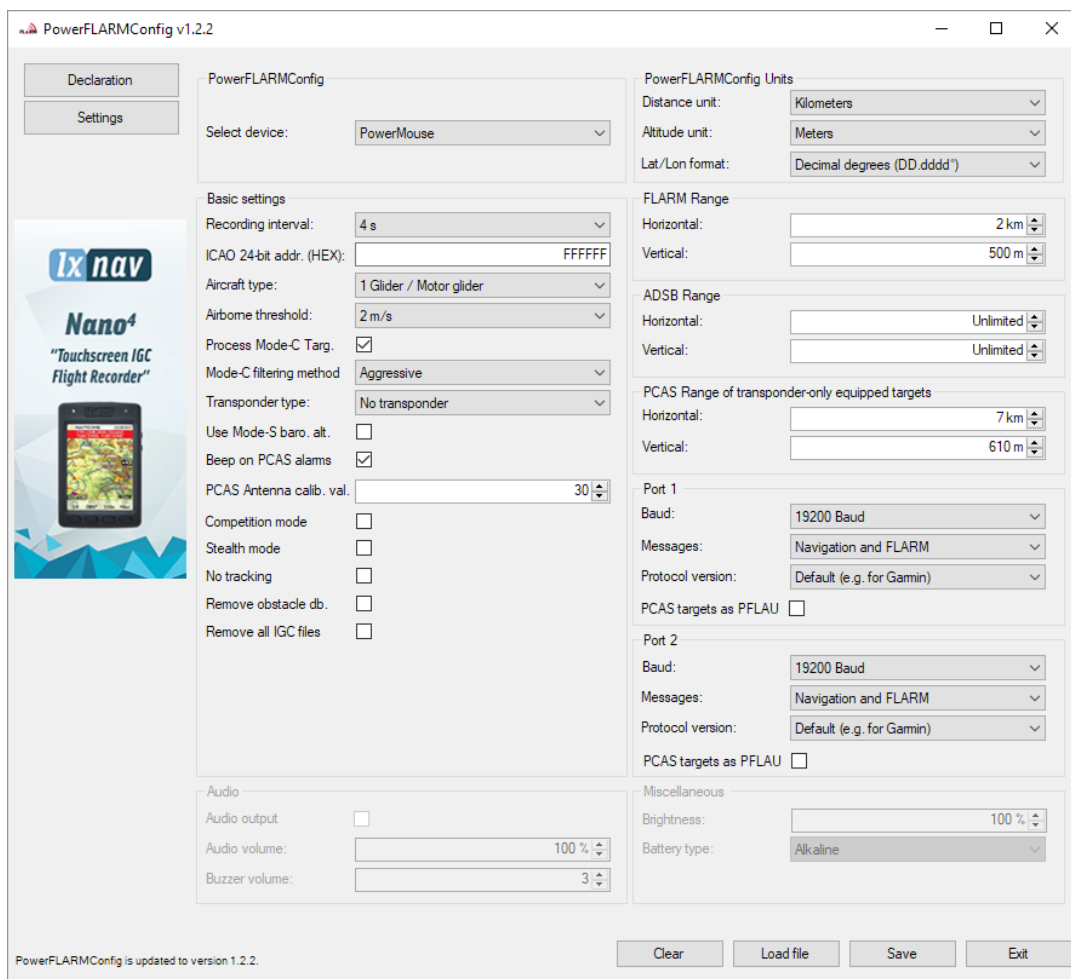

Here you can set all settings for your PowerMouse device. File will be saved as flarmcfg.txt file, which you should save on the USD memory stick. To load this file into PowerMouse, insert USB key into USB slot on PowerMouse and switch on PowerMouse. File will be automatically loaded into device.

### 6.2.2 PowerMouse configuration by using Flarm configuration tool

PowerMouse can be configured by Flarm Tool software which can be found here:

<https://flarm.com/support/tools-software/flarm-configuration-tool/>





In Farm tool are not supported all features, that can be configured for PowerMouse.

Q Search ... ABOUT US JOBS LOG IN ENGLISH

FLARM PRODUCTS SOLUTIONS TECHNOLOGY BUY NEWSROOM SUPPORT

HOME - SUPPORT - TOOLS & SOFTWARE - FLARM CONFIGURATION TOOL

## FLARM CONFIGURATION TOOL

When installing FLARM in an aircraft, and before using a portable FLARM, it is very important that it is configured correctly. Use the configuration tool below to configure your device. After selecting the desired options, the configuration file is instantly downloaded.

Note that the configuration tool only works with the latest released firmware version. Before configuring the device, you need to update to the latest firmware version, independently of when you did the last firmware update.

We take the privacy of your data seriously and you can find our Privacy policy [here](#).

My devices  
Log in to see your devices

New device  
Manufacturer: LXNAV  
Device: PowerMouse

START CONFIGURATION

**BLOG**

- 2019-01-31 New 2019 Obstacle Data Available
- 2019-01-07 Fully-automated long-range UAV flights

**Obstacles 2019**

The updated Obstacle databases for 2019 are now available in our [shop](#).

Create Config file:

- Select "New device" and choose "LXNAV" and "PowerMouse"
- Click on the button: Start configuration

Edit configuration file:

- After pressing button described above multiple options will show.
- Configure and adjust them to your liking
- More settings are available by checking "Show advance settings"

Show advanced settings

**ICAO 24-bit aircraft address, hexadecimal**  
Official 24-bit ICAO aircraft address in hexadecimal notation, as issued by local CAA. It consists of six hexadecimal characters (0-9, a-f) and can be obtained from the aircraft papers. Must match the address configured in the Mode-S transponder. If the aircraft does not have a Mode-S transponder, it's possible to leave the field empty to use the device specific radio id. Enter "0" (zero) for random id (not recommended, will make Search and Rescue (SAR) very difficult).

**Aircraft type**

The configured aircraft type will influence motion prediction and collision risk algorithms and warnings for both the own aircraft as well as other aircraft. Ensure that you select the correct type.

**Data sentences on data port 1**

According to instructions from the display/equipment manufacturer.

**Protocol version for data port 1**

"Version 4" is typically supported by all displays. Select a higher version if the display supports it to have access to all functions. Select "Version 3" if Data sentences is configured as Garmin TIS.

**Baud rate for data port 1**

Baud rate (bit rate). Must match setting in attached display/equipment. Select at least 19200 for advanced functions.

**Protocol version for data port 2**

Protocol to be used. "Version 4" is typically supported by all displays. Select a higher version if the display supports it to have access to all functions.

**Baud rate for data port 2**

Baud rate (bit rate). Must match setting in attached display/equipment. Select at least 19200 for advanced functions.

**Transponder type**

Type of transponder that is installed in the aircraft.

CREATE CONFIG FILE

Edit advance settings:

- Do this the same way as described above for standard settings

**Logging interval (seconds)**  
Applicable for IGC flight recording.  
4 (Default) ▼

**Remove all IGC files?**  
Deletes all IGC files from the device. Restarts the device.  
 Yes  
 No (Default)

**Remove obstacle database?**  
Deletes the obstacle database (if installed) from the device. Restarts the device.  
 Yes  
 No (Default)

**Pilot name**  
Applicable for IGC flight recording.

**Co-pilot name**  
Applicable for IGC flight recording.

**Glider ID**  
Applicable for IGC flight recording.

**Glider type**  
Applicable for IGC flight recording.

**Competition class of glider**  
Applicable for IGC flight recording.

**Competition ID**  
Applicable for IGC flight recording.

**Stealth mode**  
Hides tactically relevant flight data for usage at competitions. Receiving stations may use the received data for the purposes of traffic safety only or with a time delay of 10 minutes. Tactical data like climb rate are omitted or randomized.  
 Enable  
 Disable (Default)

**No-Track mode**  
Enhanced privacy mode. Receiving stations may use the received data for the purposes of traffic safety only. If enabled, Search and Rescue (SAR) based on data received by ground stations is not possible.  
 Enable  
 Disable (Default)

Create config file:

- Click button "Create config file"
- File (FLARMCFG.txt) will automatically be downloaded to your computer

CREATE CONFIG FILE

FLARMCFG (1).TXT

To load this file into PowerMouse, save it on the USD memory stick. To load this file into PowerMouse, insert USB key into USB slot on PowerMouse and switch on PowerMouse. File will be automatically loaded into device.

### 6.3 Saving flight on the USB stick

The last 20 flights will be downloaded at every switching on (only if the USB stick is inserted). If there are already some of the 20 flights on the USB stick, they will not be downloaded again. That means: if you have been flying a lot without downloading flights, the download procedure will take some time, so don't switch off. To download one flight after landing perform the following procedure: Wait a 3 minute after landing. Then switch off power for at least 5 sec. Insert the USB stick (in case it's not already inside) and switch on again.



The collision avoidance functionality does not depend on the status of the USB stick (inserted or not)

### 6.4 Updating the obstacle database

The firmware update will be executed, when the system finds a file with the extension **\*.obs.** on the USB stick root. The procedure runs identically to the firmware update and takes a few minutes. Please delete the obstacle file from the USB stick after the update.

All data must be in the USB stick root directory. Folders and subfolder are not allowed. Names of the files shall not be changed.



File format FAT16 or FAT32 and USB 2.0 type is supported.



FLARM Tools is used only for Classic FLARM and in not compatible with PowerMouse.

Obstacle database can be purchased on official flarm web site [www.flarm.com](http://www.flarm.com), section products/obstacles.

Under manufacturer please select LXNAV

For device please select PowerMouse.

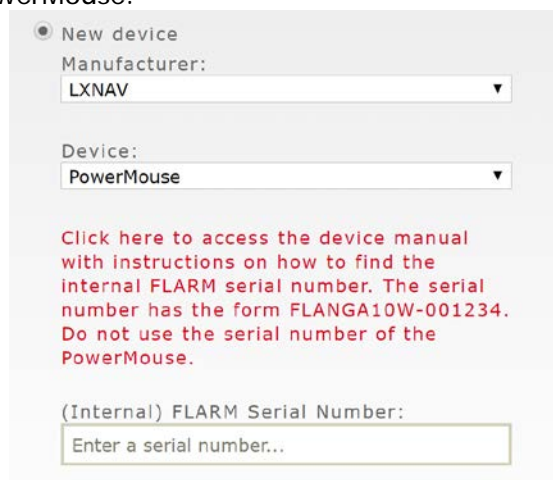

Internal serial number is available in IGC file. You will find it in following format:  
LFLA14313607DEVNO FLANGA10W-**002445**

If you open IGC file with notepad, please search for text "FLANGA10W". If you open IGC file with SeeYou, please right click and select flight properties, then Misc, scroll down for approximately one page and you will find the internal serial number.

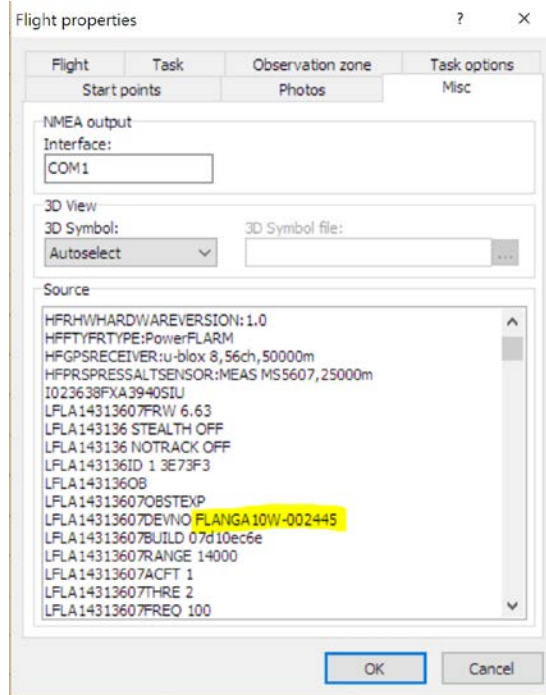

All power mouses logging IGC logs, even they don't have IGC option. PowerMouses without IGC option will have IGC flight without signature and will be not valid for badges or OLC.

## 7 Revision History

November 2017	Initial release of this manual
January 2017	New chapter 3
February 2018	Flarm Tools removed from manual
March 2018	Added chapter 4.3, Updated chapter 5
April 2018	Added chapters 5.2, 6.2.2
April 2018	Added chapters 5.3, 5.4.1.2
July 2018	Added chapters: 6.2, Updated chapter: 4.3, 5.4.1.1, 6.4
October 2018	Updated chapters: 3.2, 5.4, Added chapters: 6.1.3
December 2018	Swapped naming of port1 and port2 in Ch:5.4.1.1, 6.1.2
January 2019	Updated packing list
February 2019	Updated chapter: 6.4
March 2019	Updated chapter: 6.4
June 2019	Added Chapter:6.1.3
August 2019	Added Chapters:1.2.1, 3.1.3